





’~

g

Đ

À

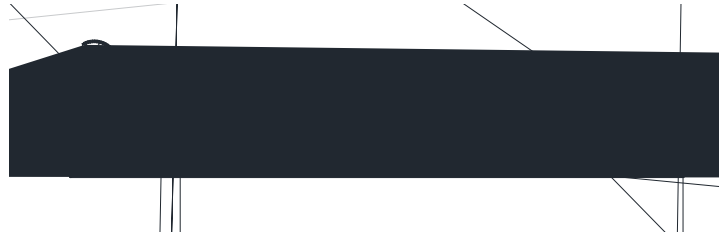

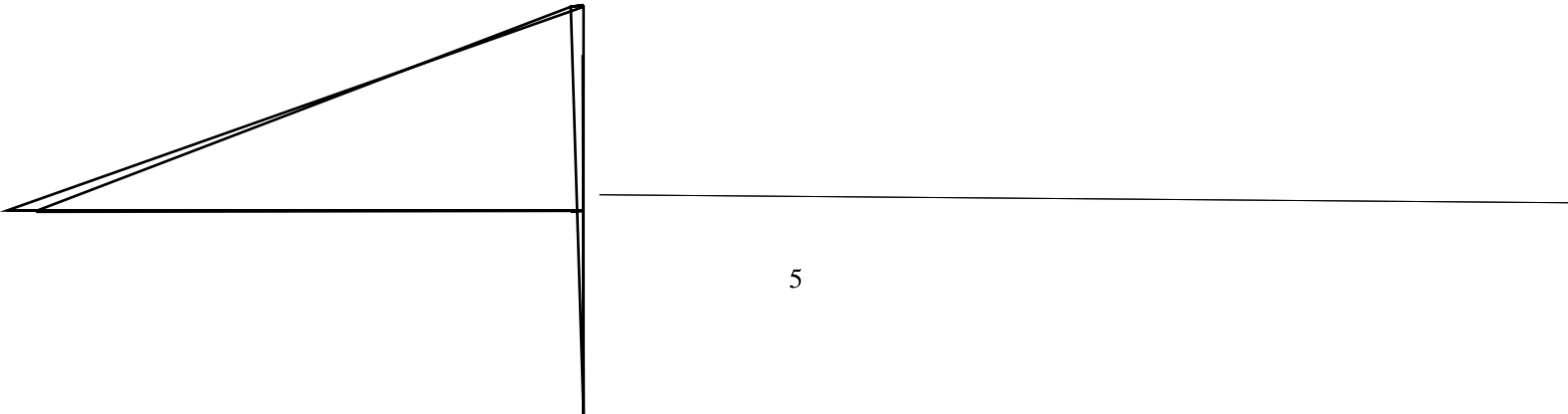
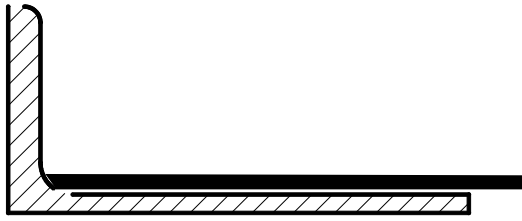

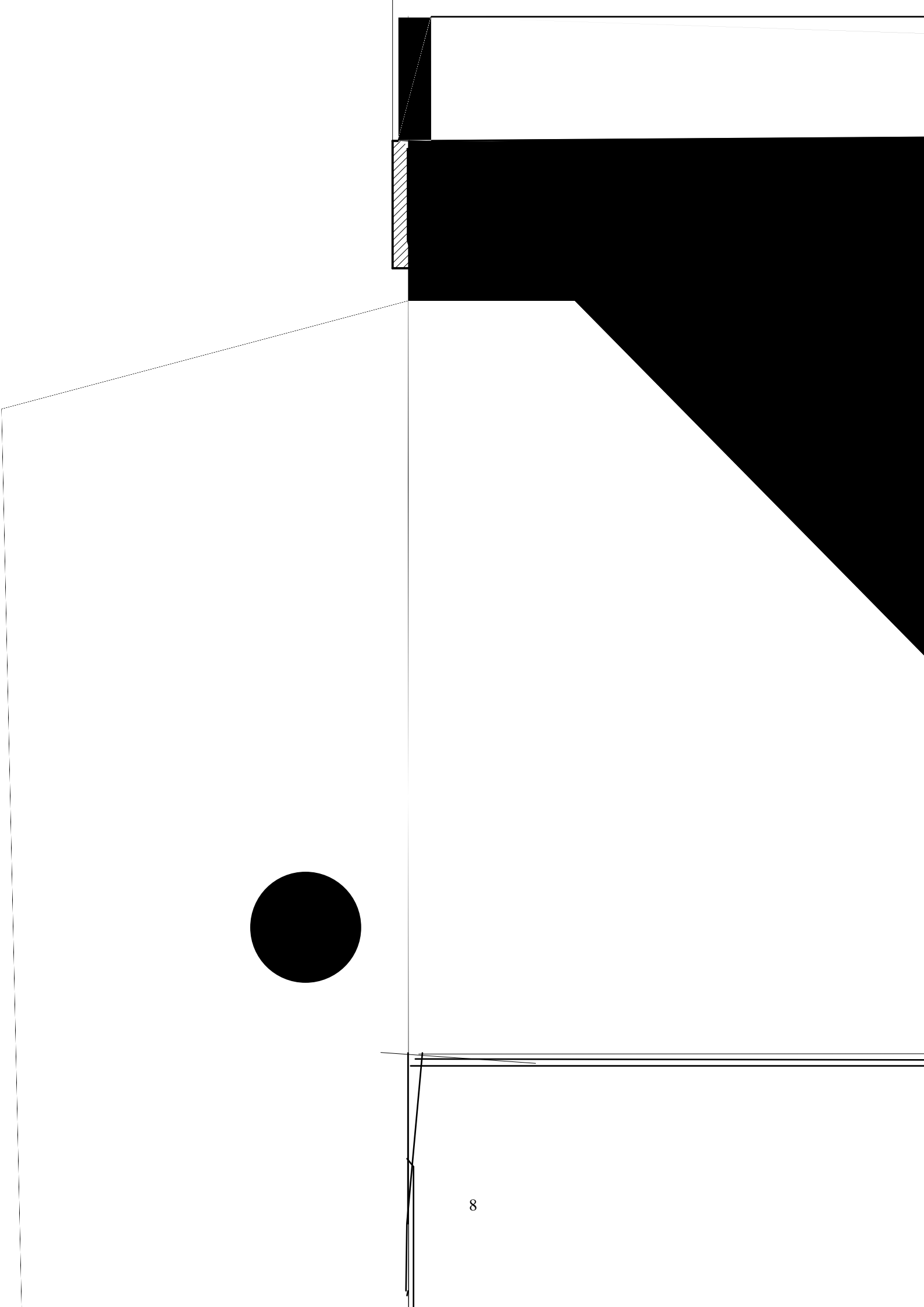

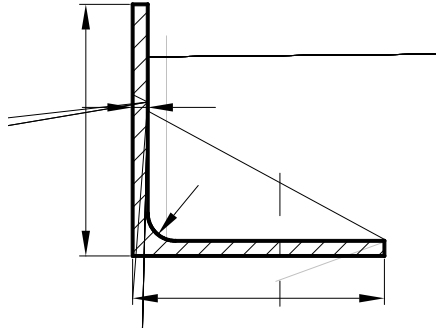

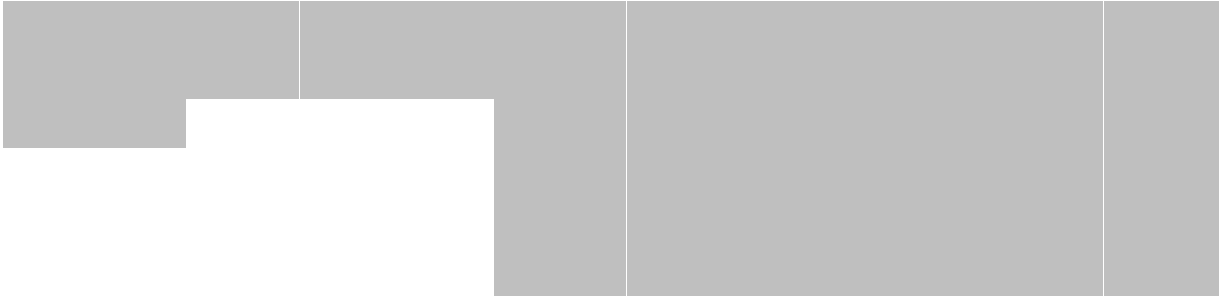

Note: Please inquire us for special requirements of thickness.

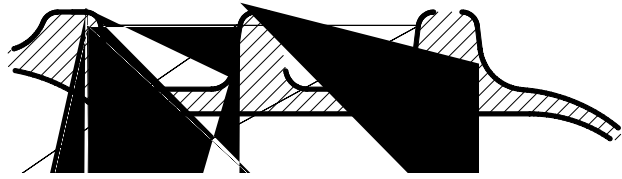

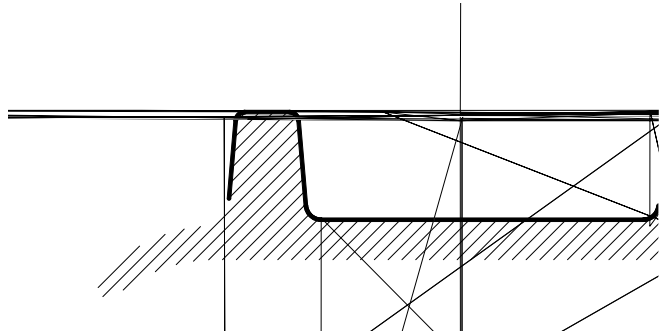

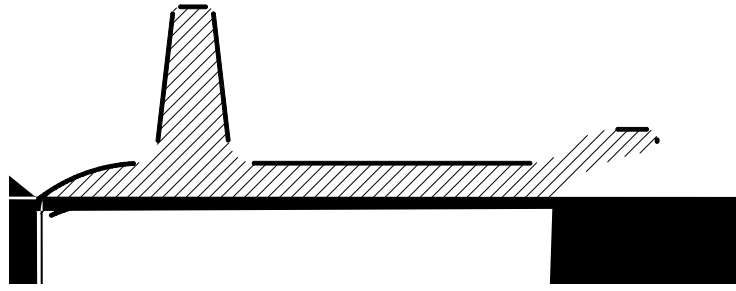

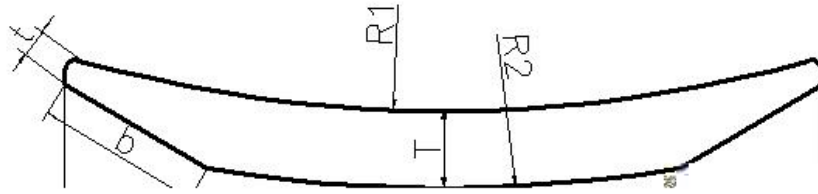

	$5.6^{+2.5}_-1$	$15.5^{+1.2}_{0.8}$	$33.3^{+1.5}_-3$	$152.4^{+3.2}_{-3.2}$	$273^{+6.4}_{-6.4}$	$292^{+6.4}_{-6.4}$		

Note: Please inquire us for special requirements of thickness.